

(NOTE: SOLID OAK EXECUTIVE LOCKER SHOWN WITHOUT SIDE PANEL OR CROWN MOLDING. PLEASE ORDER SEPARATELY.)

MODEL #11168
 SINGLE TIER SOLID OAK
 EXECUTIVE LOCKER - 1 WIDE

(1) LOCKER COMPARTMENT
 COMPARTMENT SIZE:
 14 3/4" W x 70 1/4" H x 16 3/4" D

SIDE VIEW

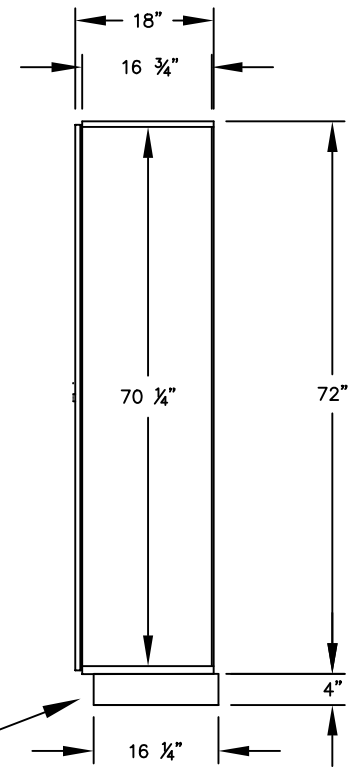

(BASES ARE MADE OF INDUSTRIAL GRADE PARTICLEBOARD AND ARE COVERED IN A DURABLE BLACK LAMINATE. PLEASE SET BASE TO ALLOW 5/8" BETWEEN THE BACK OF THE LOCKER AND THE WALL FOR AIR VENTILATION.)

MODEL #11168

18" DEEP SINGLE TIER
 SOLID OAK EXECUTIVE LOCKER
 SIX FEET HIGH (ADD 4" FOR BASE)

AVAILABLE FINISHES:
 LIGHT OAK, MEDIUM OAK, DARK OAK

DRAWN: 03/12

***Established in 1936, Salsbury Industries
 is the industry leader in manufacturing and distributing
 quality lockers and storage solutions.***